

Universal Snap-In Adapter

1796 IB (Pg1 of 1)

The Universal Snap-In Adapters are designed to be compatible with both angle and round members. The 3/4" through holes will accommodate Snap-In Hangers and both 3/8" and 10mm threaded inserts.

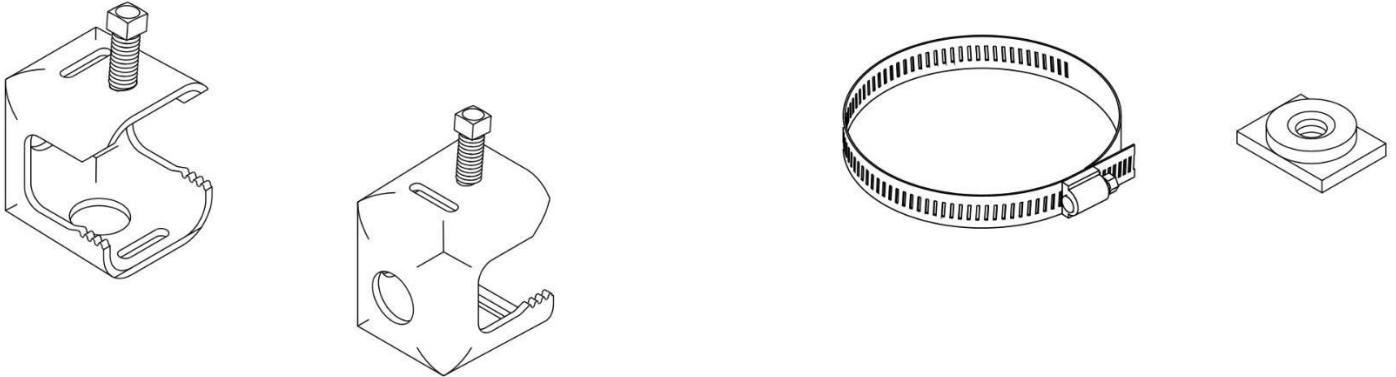

TYPICAL APPLICATIONS

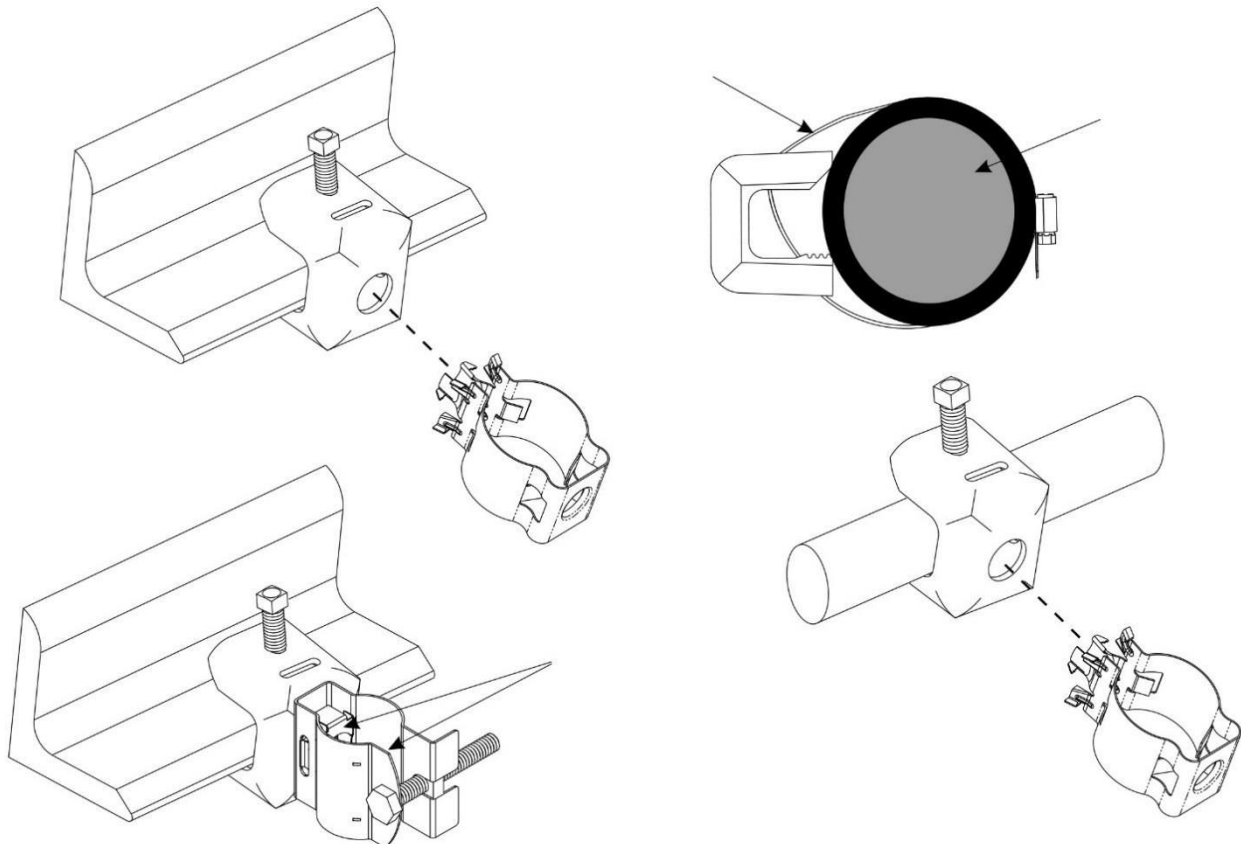

PRODUCT REFERENCE SHEET

©2020

Universal Angle Adapter

1832 A

The Universal Snap-In Adapters are designed to be compatible with both angle and round members. The 3/4" thru holes will accommodate a variety of snap style hangers, as well as 3/8" and 10mm threaded inserts. Includes torque stop set bolt to ensure proper attachment force.

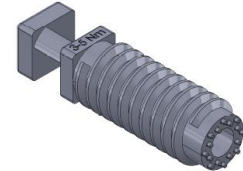
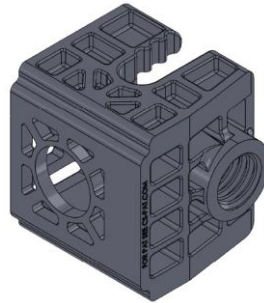
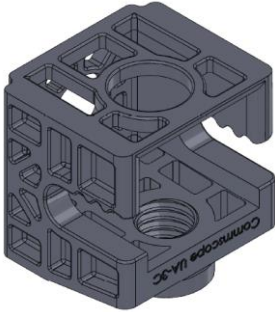

*Patent: 10910805; 10920911

TYPICAL APPLICATIONS



The torque stop screw has two heads. The top head will snap off when correct tightening torque is achieved. The bottom head will remain to enable adapter removal.

1



3-5Nm torque

Place adapter on mounting structure. Engage 1/2" wrench on top head and tighten at a slow and steady pace. The top head is designed to snap at the correct torque. Do not tighten further.

2

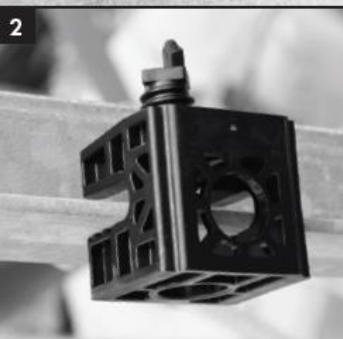

Adapter is shown here with the top head completely snapped off. This is the properly installed condition.

3



For removal, use bottom head to unscrew with 1/2" wrench head.



Maximum loading: 3 polymer hangers (shown) or two metal hangers.

Hanger	Stack Height
SSH-47	PIM free hanger for 4 to 7 mm cables
SSH-710	PIM free hanger for 7.1 to 10 mm cables
SSH-1014	PIM free hanger for 10.1 to 14 mm cables
SSH-1416	PIM free hanger for 14.1 to 16 mm cables