



RFS Technologies CDS*-43 series Directional Couplers have been designed for a variety of wireless applications in the frequency band from 694 to 3800MHz. The unit couples off a defined fraction of a RF signal from 5 to 30 dB with minimal reflections or loss. The broad frequency range is ideally suited for multi-band distributed antenna systems or in combination with RADIAFLEX® radiating cables.

FEATURES / BENEFITS

- 4.3-10-female interfaces
- PIM optimized design (160dBc @2x43dBm)
- Low insertion loss
- High power handling
- Small size, Low weight



Technical features

STRUCTURE

Product Type		Directional Coupler
Techn. Application		Indoor
Number of Input Ports		1
Number of Output Ports		2

ELECTRICAL SPECIFICATIONS

Frequency Range	MHz	694 - 3800
Connector Type		4.3-10 female
Max. VSWR / Return Loss	VSWR/dB	1.30/17.7 (1.3)
Insertion Loss max.	dB	0.4
Coupling Value	dB	15
Coupling Flatness max.	dB	±1.0
Intermodulation (IM3)		-160dBc (2x43dBm)
Impedance	Ohm	50
Total Input Power	W	400

TEMPERATURE SPECIFICATIONS

Temperature Range	°C (°F)	-25 to +65 (-13 to +149)
-------------------	---------	--------------------------

MECHANICAL SPECIFICATIONS

Height	mm (in)	28.4 (1.12)
Width	mm (in)	69.2 (2.72)
Length	mm (in)	174.8 (6.88)

TESTING AND ENVIRONMENTAL

Environmental Class		IP65
---------------------	--	------

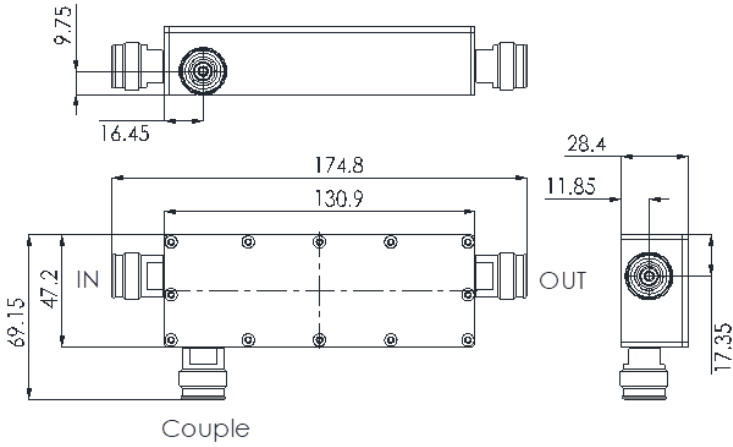

External Document Links

Notes

Directivity: $\geq 20\text{dB}$ @ 694-2700MHz, $\geq 18\text{dB}$ @ 2700-3800MHz