



HB114-U6S12-230-LI

HYBRIFLEX® Hybrid Feeder Cabling Solution 6x12, 1-1/4", 6 pairs 6AWG, Low-Inductance Coaxial Power Wire, 12 pairs Single-Mode Fiber, DLC Connectors, 230 ft

RFS Technologies' HYBRIFLEX Remote Radio Head (RRH) hybrid feeder cabling solution combines optical fiber and DC power for RRHs in a single lightweight aluminum corrugated cable, making it the world's most innovative solution for RRH deployments. It was developed to reduce installation complexity and costs at Cellular sites.

HYBRIFLEX allows mobile operators deploying an RRH architecture to standardize the RRH installation process. HYBRIFLEX combines optical fiber (multi-mode or single-mode) and power in a single corrugated cable. It may eliminate the need for junction boxes as well as works in conjunction with and can connect multiple RRHs with a single feeder. Standard RFS Technologies CELLFLEX® accessories can be used with HYBRIFLEX cable. Both pre-connectorized and on-site options are available.

FEATURES / BENEFITS

- Aluminum corrugated armor with outstanding bending characteristics – Minimizes installation time and enables mechanical protection and shielding
- Same accessories as 1-1/4" coaxial cable
- Outer conductor grounding – Utilizes same grounding methods as coaxial cable
- Lightweight solution and compact design – Decreases tower loading
- Robust cabling – Eliminates need for expensive cable trays and ducts
- Installation of tight bundled fiber optic cable pairs directly to the RRH – Reduces CAPEX and wind load by eliminating need for interconnection
- Optical fiber and power cables housed in single corrugated cable – Saves CAPEX by standardizing RRH cable installation and reducing installation requirements
- UL-Listed, flame-retardant jacket, UV protected assemblies - Allows both indoor and outdoor applications
- **Maximum robustness – Fully armored cable includes riser trunk and top outdoor breakout**



TECHNICAL FEATURES

STRUCTURE

Cable Type		HYBRIFLEX® Low Inductance
Fire Performance		Flame Retardant
Size		1-1/4"
Length	m (ft)	70.1 (230)

MECHANICAL SPECIFICATIONS

Outer Diameter Nominal	mm (in)	39.4 (1.55)
Cable Weight	kg/m (lb/ft)	2.5 (1.7)
Minimum Bending Radius, Single Bend	mm (in)	152 (6)
Minimum Bending Radius, Multiple Bends	mm (in)	254 (10)
Recommended / Maximum Clamp Spacing	m (ft)	1 / 1.2 (3.25 / 4)



HB114-U6S12-230-LI

HYBRIFLEX® Hybrid Feeder Cabling Solution 6x12, 1-1/4", 6 pairs 6AWG, Low-Inductance Coaxial Power Wire, 12 pairs Single-Mode Fiber, DLC Connectors, 230 ft

ARMOR SPECIFICATIONS

Armor Type		Corrugated Aluminum
Maximum DC-Resistance of Armor	Ω/km (Ω/kft)	0.9 (0.27)
Diameter Corrugated Armor	mm (in)	35.9 (1.41)

CABLE JACKET

UV-Protection Individual and External Jacket		Yes
--	--	-----

DC POWER CABLE SPECIFICATIONS

Number of DC Pairs		6
Maximum DC-Resistance Power Cable	Ω/km (Ω/kft)	1.4 (0.41)
Cross Section of Power Cable	mm ² (AWG)	13.3 (6)
DC Wire Jacket Material		PVC
DC Cable Single Bending Radius	mm (in)	137 (5.4)
DC Cable Diameter	mm (in)	9.3 (0.365)
DC Cable Jacket Material		PVC
DC Standards (Meets or Exceeds)		For use in UL 2882, PVC, RoHS/REACH Compliant
Break-out Length (Top)	mm (in)	812 (32)
Break-out Length (Bottom)	mm (in)	812 (32)
Alarm Wire		18 (9 twisted pairs), 0.8 mm ² (8), 18 AWG
Alarm Wire Standards (Meets or Exceeds)		UL Standard 1063, 1581 VW-1, MTW Oil and Gasoline RES1 SUNRES (Cable meets UL requirements), RoHS/REACH Compliant

F/O CABLE SPECIFICATIONS

F/O Cable Type		G657-A1 Single Mode, Bend Tolerant
Number of F/O Pairs		12
Core/Clad	μm	9/125
Secondary Protection Nominal	μm (in)	900 (0.035)
Single Bending Radius	mm (in)	157 (6.2)
Cable Diameter		5.512 (0.217)
F/O Standards (Meets or Exceeds)		UL Listed Type OFNR (UL1666), RoHS Compliant
Optical Loss	dB/Km	0.5 @ 1310 nm 0.5 @ 1550 nm
Fiber Termination End 1		DLC connector
Fiber Termination End 2		DLC connector
FO Break-out Length (Top)	mm (in)	889 (35)
FO Break-out Length (Bottom)	mm (in)	889 (35)



HB114-U6S12-230-LI

HYBRIFLEX® Hybrid Feeder Cabling Solution 6x12, 1-1/4", 6 pairs 6AWG, Low-Inductance Coaxial Power Wire, 12 pairs Single-Mode Fiber, DLC Connectors, 230 ft

TESTING AND ENVIRONMENTAL

Storage Temperature	°C (°F)	-40 to 70 (-40 to 158)
Operation Temperature	°C (°F)	-40 to 65 (-40 to 149)
Installation Temperature	°C (°F)	-20 to 65 (-4 to 149)
Jacket Specifications		UL2882, UL Listed



HB114-U6S12-230-LI

HYBRIFLEX® Hybrid Feeder Cabling Solution 6x12, 1-1/4", 6 pairs 6AWG, Low-Inductance Coaxial Power Wire, 12 pairs Single-Mode Fiber, DLC Connectors, 230 ft

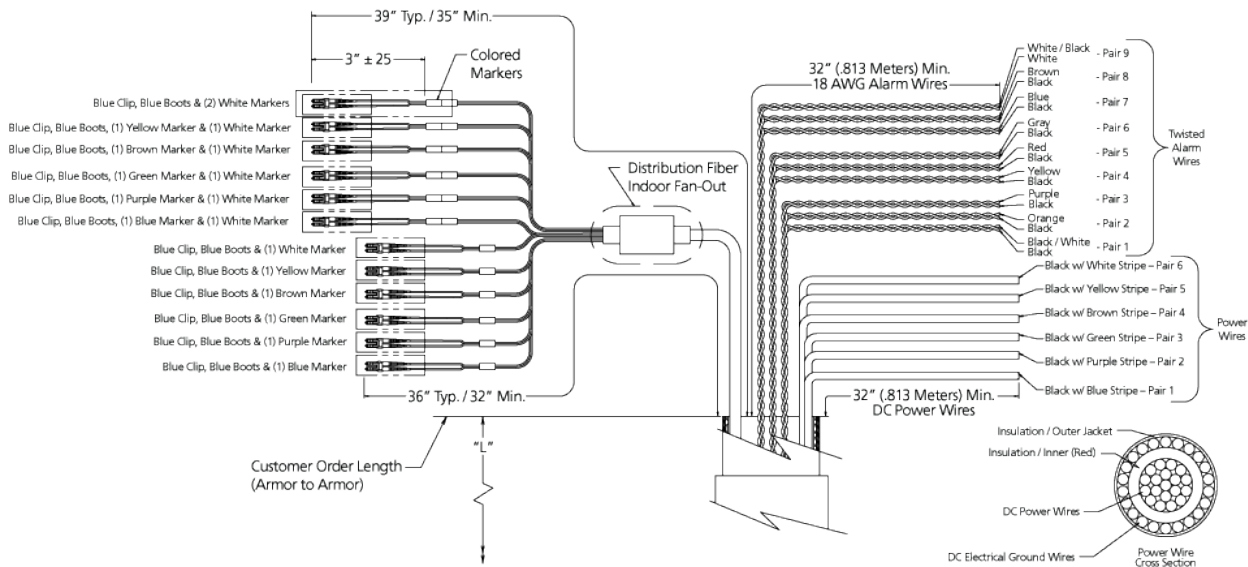

EXTERNAL DOCUMENT LINKS

QuickShip 2.0 Program Information: [Download](#)
On-line Factory Test Results: [View](#)

NOTES

Nominal length equals length of trunk not including top and bottom breakouts; breakout lengths add additionally to the total assembly length tip to tip.

Includes 9 pairs of wires used to carry alarm signals.

The package also includes a kit of special RFS-designed DC insulating boots, 1 per coaxial power wire, used to properly protect and insulate the DC wires after stripping the jacket, avoiding possible short-circuits while wiring it to the distribution boxes.

DC INSULATING BOOT

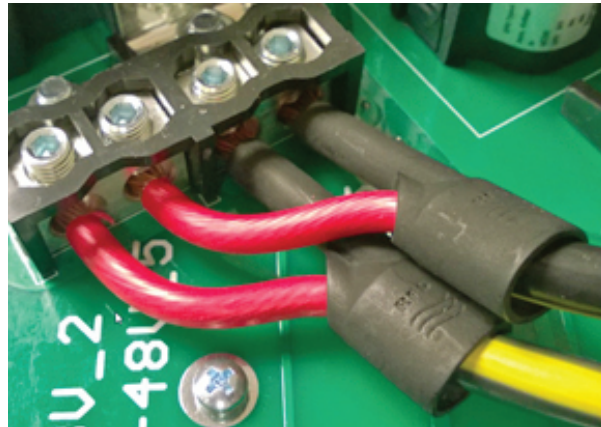



HB114-U6S12-230-LI

HYBRIFLEX® Hybrid Feeder Cabling Solution 6x12, 1-1/4", 6 pairs 6AWG, Low-Inductance Coaxial Power Wire, 12 pairs Single-Mode Fiber, DLC Connectors, 230 ft

ADDITIONAL ASSEMBLY LENGTHS

Length (ft)	Model Number
10	HB114-U6S12-10-LI
20	HB114-U6S12-20-LI
30	HB114-U6S12-30-LI
40	HB114-U6S12-40-LI
50	HB114-U6S12-50-LI
60	HB114-U6S12-60-LI
70	HB114-U6S12-70-LI
80	HB114-U6S12-80-LI
90	HB114-U6S12-90-LI
100	HB114-U6S12-100-LI
110	HB114-U6S12-110-LI
120	HB114-U6S12-120-LI
130	HB114-U6S12-130-LI
140	HB114-U6S12-140-LI
150	HB114-U6S12-150-LI
160	HB114-U6S12-160-LI
170	HB114-U6S12-170-LI
180	HB114-U6S12-180-LI
190	HB114-U6S12-190-LI
200	HB114-U6S12-200-LI
210	HB114-U6S12-210-LI
220	HB114-U6S12-220-LI
230	HB114-U6S12-230-LI
240	HB114-U6S12-240-LI
250	HB114-U6S12-250-LI
260	HB114-U6S12-260-LI
270	HB114-U6S12-270-LI
280	HB114-U6S12-280-LI
290	HB114-U6S12-290-LI
300	HB114-U6S12-300-LI
310	HB114-U6S12-310-LI
320	HB114-U6S12-320-LI
330	HB114-U6S12-330-LI
340	HB114-U6S12-340-LI
350	HB114-U6S12-350-LI
360	HB114-U6S12-360-LI

ADDITIONAL ASSEMBLY LENGTHS

Length (ft)	Model Number
370	HB114-U6S12-370-LI
380	HB114-U6S12-380-LI
390	HB114-U6S12-390-LI
400	HB114-U6S12-400-LI
410	HB114-U6S12-410-LI
420	HB114-U6S12-420-LI
430	HB114-U6S12-430-LI
440	HB114-U6S12-440-LI
450	HB114-U6S12-450-LI
460	HB114-U6S12-460-LI
470	HB114-U6S12-470-LI
480	HB114-U6S12-480-LI
490	HB114-U6S12-490-LI
500	HB114-U6S12-500-LI
510	HB114-U6S12-510-LI
520	HB114-U6S12-520-LI
530	HB114-U6S12-530-LI
540	HB114-U6S12-540-LI
550	HB114-U6S12-550-LI
560	HB114-U6S12-560-LI
570	HB114-U6S12-570-LI
580	HB114-U6S12-580-LI
590	HB114-U6S12-590-LI
600	HB114-U6S12-600-LI
610	HB114-U6S12-610-LI
620	HB114-U6S12-620-LI
640	HB114-U6S12-640-LI
670	HB114-U6S12-670-LI
700	HB114-U6S12-700-LI
750	HB114-U6S12-750-LI
800	HB114-U6S12-800-LI
850	HB114-U6S12-850-LI
900	HB114-U6S12-900-LI
950	HB114-U6S12-950-LI
1000	HB114-U6S12-1000-LI



HB114-U6S12-230-LI

HYBRIFLEX® Hybrid Feeder Cabling Solution 6x12, 1-1/4", 6 pairs 6AWG, Low-Inductance Coaxial Power Wire, 12 pairs Single-Mode Fiber, DLC Connectors, 230 ft

PRE-PACKED HYBRIFLEX KITS FOR EASY INTEGRATION INTO RAYCAP JUNCTION BOXES

RFS Technologies now offers Kitting options for most hybrid risers and jumpers that include both the cable assembly and the Raycap inserts. For reference, kits have a "K" as the third digit in the model number. HB158 does not require an additional gland/insert for proper installation and sealing into the Distribution Boxes.

Kit Model Prefix	Assembly Prefix	Assembly Qty	Raycap Insert Kit	Insert Kit Contents	Raycap Insert Kit Qty
HBK114	HB114	1	RFS Technologies-TRUNK-KIT	(2) 190 0620, Insert, M75, 1H, 40mm	1
HBK058	HBF058		RFS Technologies-JUMP-KIT	(1) 190 0621, Insert, M75, 3H, 22mm, Split w/ plugs	
HBK012	HBF012		RFS Technologies-JUMP-KIT-2	(1) 190 0903, Insert, M75, 2H, 15mm, Split w/ plugs	
FRK-N	FR-N		RFS Technologies-FIBER-KIT	(1) 190 0657, Insert, M75, 6H, 6.1mm, Split w/ plugs	