



HB158-21U6S12-80M-01

HYBRIFLEX® Hybrid Feeder Cabling Solution 6x12, 4AWG, 1-5/8", Single-Mode Fiber, DLC to ODC, with 6AWG DC breakout top, 80 m

PRODUCT DESCRIPTION

RFS Technologies' HYBRIFLEX Remote Radio Head (RRH) hybrid feeder cabling solution combines optical fiber and DC power for RRHs in a single lightweight aluminum corrugated cable, making it the world's most innovative solution for RRH deployments. It was developed to reduce installation complexity and costs at Cellular sites.

HYBRIFLEX allows mobile operators deploying an RRH architecture to standardize the RRH installation process. HYBRIFLEX combines optical fiber (multi-mode or single-mode) and power in a single corrugated cable. It eliminates the need for junction boxes and can connect multiple RRHs with a single feeder. Standard RFS Technologies CELLFLEX® accessories can be used with HYBRIFLEX cable. Both pre-connectorized and on-site options are available.



FEATURES / BENEFITS

- Aluminum corrugated armor with outstanding bending characteristics – Minimizes installation time and enables mechanical protection and shielding
- Armored fiber optic breakout – Preserves the integrity of the fiber and provides mechanical/environmental protection
- Same accessories as 1-5/8" coaxial cable
- Outer conductor grounding – Utilizes same grounding methods as coaxial cable
- Lightweight solution and compact design – Decreases tower loading
- Robust cabling – Eliminates need for expensive cable trays and ducts
- Installation of tight bundled fiber optic cable pairs directly to the RRH – Reduces CAPEX and wind load by eliminating need for interconnection
- Optical fiber and power cables housed in single corrugated cable – Saves CAPEX by standardizing RRH cable installation and reducing installation requirements
- Outdoor, black PE jacket – Ensures long-lasting cable protection
- Shielded DC wire – Jacketed and braided cable on top breakout provides grounding and EMI protection
- **Maximum robustness – Fully armored cable includes riser trunk and top outdoor breakout**

TECHNICAL FEATURES

STRUCTURE

Cable Type		HYBRIFLEX®
Size		1-5/8"
Length	m (ft)	80 (262.4)

MECHANICAL SPECIFICATIONS

Outer Diameter Nominal	mm (in)	50.7 (1.99)
Cable Weight	kg/m (lb/ft)	3.42 (2.3)
Minimum Bending Radius, Single Bend	mm (in)	250 (10)
Minimum Bending Radius, Multiple Bends	mm (in)	500 (20)
Recommended / Maximum Clamp Spacing	m (ft)	1 / 1.2 (3.25 / 4)



HB158-21U6S12-80M-01

HYBRIFLEX® Hybrid Feeder Cabling Solution 6x12, 4AWG, 1-5/8", Single-Mode Fiber, DLC to ODC, with 6AWG DC breakout top, 80 m

ARMOR SPECIFICATIONS

Armor Type		Corrugated Aluminum
Maximum DC-Resistance of Armor	Ω/km (Ω/kft)	0.58 (0.178)
Diameter Corrugated Armor	mm (in)	46.4 (1.83)

CABLE JACKET

UV-Protection Individual and External Jacket		Yes
--	--	-----

DC POWER CABLE SPECIFICATIONS

Number of DC Pairs		6
Maximum DC-Resistance Power Cable	Ω/km (Ω/kft)	0.83 (0.25)
Cross Section of Power Cable	mm ² (AWG)	21.1 (4)
DC Wire Jacket Material		PVC/Nylon
DC Cable Single Bending Radius	mm (in)	137 (5.4)
DC Cable Diameter	mm (in)	7.8 (0.308)
DC Standards (Meets or Exceeds)		For use in UL 1569, PVC Nylon, RoHS/REACH Compliant
Break-out Length (Top)	mm (in)	4000 (157)
Break-out Length (Bottom)	mm (in)	355 (14)
DC Cable Sealing Method		Semi-rigid flame-retardant polyolefin, with hot melt adhesive

F/O CABLE SPECIFICATIONS

F/O Cable Type		G657-A1 Single Mode, Bend Tolerant
Number of F/O Pairs		12
Core/Clad	μm	9/125
Secondary Protection Nominal	μm (in)	900 (0.035)
Single Bending Radius	mm (in)	157 (6.2)
Cable Diameter		5.512 (0.217)
F/O Standards (Meets or Exceeds)		UL Listed Type OFNR (UL1666), RoHS Compliant
Optical Loss	dB/Km	0.5 @ 1310 nm 0.5 @ 1550 nm
Fiber Termination End 1		ODC plug
Fiber Termination End 2		DLC connector
FO Break-out Length (Top)	mm (in)	914 (36)
FO Break-out Length (Bottom)	mm (in)	1670 (65.7)
Cable Sealing Method		Semi-rigid flame-retardant polyolefin, with hot melt adhesive

TESTING AND ENVIRONMENTAL

Storage Temperature	°C (°F)	-40 to 70 (-40 to 158)
Operation Temperature	°C (°F)	-40 to 65 (-40 to 149)
Installation Temperature	°C (°F)	-20 to 65 (-4 to 149)



HB158-21U6S12-80M-01

HYBRIFLEX® Hybrid Feeder Cabling Solution 6x12, 4AWG, 1-5/8", Single-Mode Fiber, DLC to ODC, with 6AWG DC breakout top, 80 m

ASSEMBLY LOSS

Optical Insertion Loss, Riser or Jumper Tested Individually	Riser or Jumper	0.4 dB typical @1310/1550nm
--	-----------------	-----------------------------

SYSTEM LOSS

Optical Insertion Loss, Riser and Jumper Connected in Series	Total, End to End	0.7dB typical / 1.25dB max @1310/1550nm
---	-------------------	---



HB158-21U6S12-80M-01

HYBRIFLEX® Hybrid Feeder Cabling Solution 6x12, 4AWG, 1-5/8", Single-Mode Fiber, DLC to ODC, with 6AWG DC breakout top, 80 m

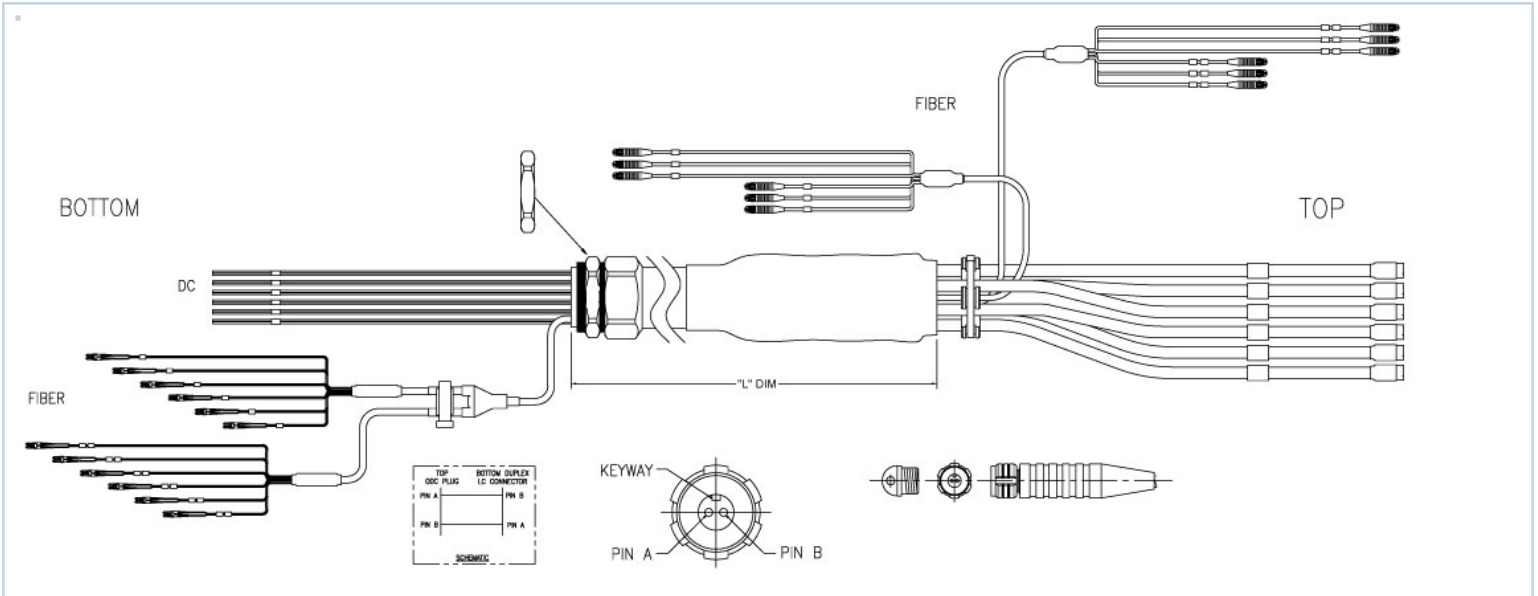

EXTERNAL DOCUMENT LINKS

On-line Factory Test Results: [View](#)

NOTES

Nominal length equals length of trunk not including top and bottom breakouts; breakout lengths add additionally to the total assembly length tip to tip

Top Breakout - DC Power Cable Specifications:

- No of DC pairs 6; Specifications per 1 pair:
- Maximum DC-Resistance Power Cable Ω /km (Ω /ft) 1.4 (0.42),
- Cross Section of Power Cable mm² (AWG) 13.3 (6),
- Overall Cable Diameter mm (in) 11.5 (0.453),
- DC Cable Jacket Material PVC,
- EMI Shield Tinned Copper Braid

ADDITIONAL ASSEMBLY LENGTHS

Length (m)	Model Number
40	HB158-21U6S12-40M-01
50	HB158-21U6S12-50M-01
60	HB158-21U6S12-60M-01
70	HB158-21U6S12-70M-01
80	HB158-21U6S12-80M-01
90	HB158-21U6S12-90M-01
100	HB158-21U6S12-100M-01
110	HB158-21U6S12-110M-01
120	HB158-21U6S12-120M-01
130	HB158-21U6S12-130M-01



HB158-21U6S12-80M-01

HYBRIFLEX® Hybrid Feeder Cabling Solution 6x12, 4AWG, 1-5/8", Single-Mode Fiber, DLC to ODC, with 6AWG DC breakout top, 80 m

PRE-PACKED HYBRIFLEX KITS FOR QUICK AND EASY FIELD INSTALLS

All Kits include an above cable assembly plus predefined quantities of grounding kit(s) and hoisting grip(s)

KIT ASSEMBLY LENGTHS

Length (m)	Model Number	Grounding Kit	GK Qty	Hoisting Grip	HG Qty
40	HB158-21U6S12-40M-KIT-01	GKFORM60-158	3	HOIST1-158L	2
50	HB158-21U6S12-50M-KIT-01		3		2
60	HB158-21U6S12-60M-KIT-01		3		2
70	HB158-21U6S12-70M-KIT-01		4		4
80	HB158-21U6S12-80M-KIT-01		4		4
90	HB158-21U6S12-90M-KIT-01		4		4
100	HB158-21U6S12-100M-KIT-01		5		4
110	HB158-21U6S12-110M-KIT-01		5		4
120	HB158-21U6S12-120M-KIT-01		5		4
130	HB158-21U6S12-130M-KIT-01		6		6