



HBF058-08U2SS2-60FY

HYBRIFLEX® RRH Hybrid Jumper, 5/8", 2 pair 8AWG, 2 Single Strand, Single-Mode Fiber with LC to LC/FullAXS Compatible Connectors, 60 ft

PRODUCT DESCRIPTION

RFS Technologies' HYBRIFLEX Remote Radio Head (RRH) hybrid feeder cabling solution combines optical fiber and DC power for RRHs, making it the world's most innovative solution for RRH deployments. It was developed to reduce installation complexity and costs at Cellular sites. HYBRIFLEX allows mobile operators deploying an RRH architecture to standardize the RRH installation process. HYBRIFLEX combines optical fiber (multi-mode or single-mode) and power in a single corrugated cable. It may eliminate the need for junction boxes and can connect multiple RRHs with a single feeder. Standard RFS Technologies CELLFLEX® accessories can be used with HYBRIFLEX cable. Both pre-connectorized and on-site options are available.



FEATURES / BENEFITS

- Y Splice power wire for junction box connections - 2 pairs power into 1 position in box
- Lightweight solution and compact design - Decreases tower loading
- Robust cabling - Eliminates need for expensive cable trays and ducts
- Optical fiber and power cables housed in single cable - Saves CAPEX by standardizing RRH cable installation and reducing installation requirements
- UL-Listed components, flame-retardant jacket, UV protected assemblies - Allows both indoor and outdoor applications
- **100% Factory tested - Online test results available**

TECHNICAL FEATURES

STRUCTURE

| | | |
|------------------|--------|-----------------|
| Cable Type | | HYBRIFLEX® |
| Fire Performance | | Flame Retardant |
| Size | | 5/8 |
| Length | m (ft) | 18.3 (60) |

MECHANICAL SPECIFICATIONS

| | | |
|--|--------------|--------------------|
| Outer Diameter Nominal | mm (in) | 21.4 (0.84) |
| Cable Weight | kg/m (lb/ft) | 0.5 (0.34) |
| Minimum Bending Radius, Single Bend | mm (in) | 102 (4) |
| Minimum Bending Radius, Multiple Bends | mm (in) | 254 (10) |
| Recommended / Maximum Clamp Spacing | m (ft) | 1 / 1.2 (3.25 / 4) |

CABLE JACKET

| | | |
|--|--|-----|
| UV-Protection Individual and External Jacket | | Yes |
|--|--|-----|



HBF058-08U2SS2-60FY

HYBRIFLEX® RRH Hybrid Jumper, 5/8", 2 pair 8AWG, 2 Single Strand, Single-Mode Fiber with LC to LC/FullAXS Compatible Connectors, 60 ft

DC POWER CABLE SPECIFICATIONS

| | | |
|-----------------------------------|-----------------------|---|
| Number of DC Pairs | | 2 |
| Maximum DC-Resistance Power Cable | Ω/km (Ω/kft) | 2.2 (0.66) |
| Cross Section of Power Cable | mm ² (AWG) | 8.4 (8) |
| DC Wire Jacket Material | | PVC/Nylon |
| DC Cable Single Bending Radius | mm (in) | 83 (3.3) |
| DC Cable Diameter | mm (in) | 5.5 (0.22) |
| DC Standards (Meets or Exceeds) | | For use in Type MC per UL 1569, PVC Nylon, RoHS/REACH Compliant |
| Break-out length (Top) | mm (in) | 508 (20) |
| Break-out length (Bottom) | mm (in) | 508 (20) |
| DC cable sealing method | | Semi-rigid, flame-retardant polyolefin, with hot melt adhesive |

F/O CABLE SPECIFICATIONS

| | | |
|----------------------------------|---------|---|
| Number of F/O Strands | | 2 |
| F/O Cable Type | | G657-A2 Single Mode, Bend Tolerant |
| Core/Clad | μm | 9/125 |
| Single Bending Radius | mm (in) | 83 (3.3) |
| F/O Standards (Meets or Exceeds) | | UL Listed Type OFNR (UL1666), RoHS Compliant |
| Optical Loss | dB/Km | 0.5 @ 1310 nm 0.5 @ 1550 nm |
| FO Break-out Length (Top) | mm (in) | 508 (20) |
| FO Break-out Length (Bottom) | mm (in) | 1047 (58) |
| Cable Sealing Method | | Semi-rigid flame-retardant polyolefin, with hot melt adhesive |

| | | |
|-------------------------|--|---|
| Fiber Termination End 1 | | LC Connector |
| Fiber Termination End 2 | | LC Connector with FullAXS Compatibility |

TESTING AND ENVIRONMENTAL

| | | |
|--------------------------|---------|---------------------------|
| Storage Temperature | °C (°F) | -40 to 70 (-40 to 158) |
| Operation Temperature | °C (°F) | -40 to 65 (-40 to 149) |
| Installation Temperature | °C (°F) | -20 to 65 (-4 to 149) |
| Jacket Specifications | | UL1569 Type MC, UL Listed |

EXTERNAL DOCUMENT LINKS

Installation Guidelines: [Download](#)
 QuickShip 2.0 Program Information: [Download](#)
 On-line Factory Test Results: [View](#)

NOTES

Y-Cable DC Splice on Bottom Breakout, 2 pair DC into 1 pair, for single position DC connection in tower top junction box.



HBF058-08U2SS2-60FY

HYBRIFLEX® RRH Hybrid Jumper, 5/8", 2 pair 8AWG, 2 Single Strand, Single-Mode Fiber with LC to LC/FullAXS Compatible Connectors, 60 ft

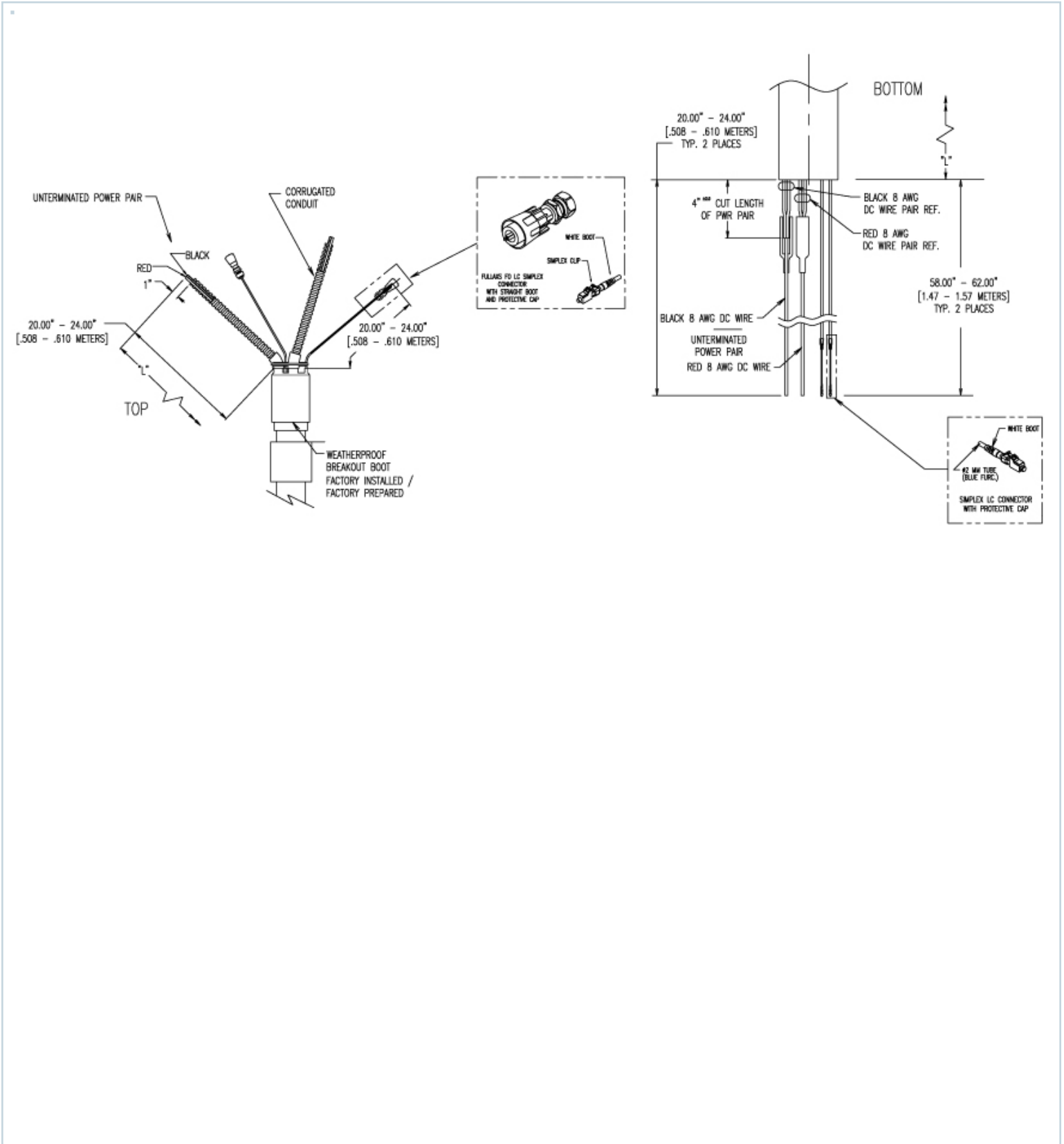



HBF058-08U2SS2-60FY

HYBRIFLEX® RRH Hybrid Jumper, 5/8", 2 pair 8AWG, 2 Single Strand, Single-Mode Fiber with LC to LC/FullAXS Compatible Connectors, 60 ft

ADDITIONAL ASSEMBLIES - 1 PAIR SM FIBER

| Length, ft | Model Number |
|------------|---------------------|
| 8 | HBF058-08U2S1-08FY |
| 9 | HBF058-08U2S1-09FY |
| 10 | HBF058-08U2S1-10FY |
| 12 | HBF058-08U2S1-12FY |
| 15 | HBF058-08U2S1-15FY |
| 20 | HBF058-08U2S1-20FY |
| 30 | HBF058-08U2S1-30FY |
| 40 | HBF058-08U2S1-40FY |
| 60 | HBF058-08U2S1-60FY |
| 80 | HBF058-08U2S1-80FY |
| 150 | HBF058-08U2S1-150FY |

ADDITIONAL ASSEMBLIES - 2 PAIR SM FIBER

| Length, ft | Model Number |
|------------|--------------------|
| 8 | HBF058-08U2S2-08FY |
| 9 | HBF058-08U2S2-09FY |
| 12 | HBF058-08U2S2-12FY |
| 15 | HBF058-08U2S2-15FY |
| 20 | HBF058-08U2S2-20FY |
| 30 | HBF058-08U2S2-30FY |
| 40 | HBF058-08U2S2-40FY |
| 70 | HBF058-08U2S2-70FY |
| | |
| | |
| | |



HBF058-08U2SS2-60FY

HYBRIFLEX® RRH Hybrid Jumper, 5/8", 2 pair 8AWG, 2 Single Strand, Single-Mode Fiber with LC to LC/FullAXS Compatible Connectors, 60 ft

ADDITIONAL ASSEMBLIES - 1 STRAND SM FIBER

| Length, ft | Model Number |
|------------|--------------------|
| 8 | HBF058-08U2SS-08FY |
| 12 | HBF058-08U2SS-12FY |
| 15 | HBF058-08U2SS-15FY |
| 20 | HBF058-08U2SS-20FY |
| 30 | HBF058-08U2SS-30FY |
| | |
| | |
| | |
| | |
| | |

ADDITIONAL ASSEMBLIES - 2 STRAND SM FIBER

| Length, ft | Model Number |
|------------|---------------------|
| 10 | HBF058-08U2SS2-10FY |
| 20 | HBF058-08U2SS2-20FY |
| 30 | HBF058-08U2SS2-30FY |
| 40 | HBF058-08U2SS2-40FY |
| 50 | HBF058-08U2SS2-50FY |
| 60 | HBF058-08U2SS2-60FY |
| 70 | HBF058-08U2SS2-70FY |
| 80 | HBF058-08U2SS2-80FY |
| 90 | HBF058-08U2SS2-90FY |
| 100 | HBF058-08U2SS2100FY |

PRE-PACKED HYBRIFLEX KITS FOR EASY INTEGRATION INTO RAYCAP JUNCTION BOXES

RFS Technologies now offers Kitting options for most hybrid risers and jumpers that include both the cable assembly and the Raycap inserts. For reference, kits have a "K" as the third digit in the model number. HB158 does not require an additional gland/insert for proper installation and sealing into the Distribution Boxes.

| Kit Model Prefix | Assembly Prefix | Assembly Qty | Raycap Insert Kit | Insert Kit Contents | Raycap Insert Kit Qty |
|------------------|-----------------|--------------|-----------------------------|--|-----------------------|
| HBK114 | HB114 | 1 | RFS Technologies-TRUNK-KIT | (2) 190 0620, Insert, M75, 1H, 40mm | 1 |
| HBK058 | HBF058 | | RFS Technologies-JUMP-KIT | (1) 190 0621, Insert, M75, 3H, 22mm, Split w/ plugs | |
| HBK012 | HBF012 | | RFS Technologies-JUMP-KIT-2 | (1) 190 0903, Insert, M75, 2H, 15mm, Split w/ plugs | |
| FRK-N | FR-N | | RFS Technologies-FIBER-KIT | (1) 190 0657, Insert, M75, 6H, 6.1mm, Split w/ plugs | |