



HBF058-13U1SS3-15FS

HYBRIFLEX® RRH Hybrid Jumper, 5/8", 1 pair 6AWG, 3 Single Strand, Single-Mode Fiber with LC to Elongated LC Clip, 15 ft

PRODUCT DESCRIPTION

RFS Technologies' HYBRIFLEX Remote Radio Head (RRH) hybrid feeder cabling solution combines optical fiber and DC power for RRHs in a single lightweight aluminum corrugated cable, making it the world's most innovative solution for RRH deployments. It was developed to reduce installation complexity and costs at Cellular sites. HYBRIFLEX allows mobile operators deploying an RRH architecture to standardize the RRH installation process. HYBRIFLEX combines optical fiber (multi-mode or single-mode) and power in a single corrugated cable. It may eliminate the need for junction boxes and can connect multiple RRHs with a single feeder. Standard RFS Technologies CELLFLEX® accessories can be used with HYBRIFLEX cable.

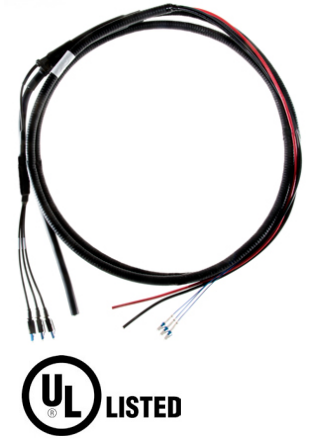

FEATURES / BENEFITS

- Aluminum corrugated armor with outstanding bending characteristics - Minimizes installation time and enables mechanical protection and shielding
- Outer conductor grounding - Saves on installation costs
- Lightweight solution and compact design - Decreases tower loading
- Robust cabling - Eliminates need for expensive cable trays and ducts
- Installation of tight bundled fiber optic cable pairs directly to the RRH - Reduces CAPEX and wind load by eliminating need for interconnection
- Optical fiber and power cables housed in single corrugated cable - Saves CAPEX by standardizing RRH cable installation and reducing installation requirements
- UL-Listed, flame-retardant jacket, UV protected assemblies - Allows both indoor and outdoor applications
- **100% Factory tested - Online test results available**

TECHNICAL FEATURES

STRUCTURE

Cable Type		HYBRIFLEX®
Fire Performance		Flame Retardant
Size		5/8
Length	m (ft)	4.5 (15)

MECHANICAL SPECIFICATIONS

Outer Diameter Nominal	mm (in)	21.4 (0.84)
Cable Weight	kg/m (lb/ft)	0.6 (0.4)
Minimum Bending Radius, Single Bend	mm (in)	102 (4)
Minimum Bending Radius, Multiple Bends	mm (in)	254 (10)
Recommended / Maximum Clamp Spacing	m (ft)	1 / 1.2 (3.25 / 4)

CABLE JACKET

UV-Protection Individual and External Jacket		Yes
--	--	-----



HBF058-13U1SS3-15FS

HYBRIFLEX® RRH Hybrid Jumper, 5/8", 1 pair 6AWG, 3 Single Strand, Single-Mode Fiber with LC to Elongated LC Clip, 15 ft

ARMOR SPECIFICATIONS

Armor Type		Corrugated Aluminum
Maximum DC-resistance of Armor		1.97 (0.6)
Diameter Corrugated Armor		18.5 (0.73)

DC POWER CABLE SPECIFICATIONS

Number of DC Pairs		1
Maximum DC-Resistance Power Cable	Ω/km (Ω/kft)	1.4 (0.42)
Cross Section of Power Cable	mm ² (AWG)	13.3 (6)
DC Wire Jacket Material		PVC/Nylon
DC Cable Single Bending Radius	mm (in)	83 (3.3)
DC Cable Diameter	mm (in)	6.45 (0.25)
DC Standards (Meets or Exceeds)		For use in Type MC per UL 1569, PVC Nylon, RoHS/REACH Compliant
Break-out length (Top)	mm (in)	650 (26)
Break-out length (Bottom)	mm (in)	914 (36)
DC cable sealing method		Semi-rigid, flame-retardant polyolefin, with hot melt adhesive

F/O CABLE SPECIFICATIONS

Number of F/O Strands		3
F/O Cable Type		G657-A2 Single Mode, Bend Tolerant
Core/Clad	μm	9/125
Single Bending Radius	mm (in)	55 (2.2)
F/O Standards (Meets or Exceeds)		UL Listed Type OFNR (UL1666), RoHS Compliant
Optical Loss	dB/Km	0.5 @ 1310 nm 0.5 @ 1550 nm
FO Break-out Length (Top)	mm (in)	570 (22)
FO Break-out Length (Bottom)	mm (in)	965 (38)
Cable Sealing Method		Semi-rigid flame-retardant polyolefin, with hot melt adhesive
Fiber Termination End 1		LC Connector
Fiber Termination End 2		LC Connector with Elongated Clip

TESTING AND ENVIRONMENTAL

Storage Temperature	°C (°F)	-40 to 70 (-40 to 158)
Operation Temperature	°C (°F)	-40 to 65 (-40 to 149)
Installation Temperature	°C (°F)	-20 to 65 (-4 to 149)
Jacket Specifications		UL1569 Type MC, UL Listed

EXTERNAL DOCUMENT LINKS

QuickShip 2.0 Program Information: [Download](#)
 On-line Factory Test Results: [View](#)

NOTES

Top Breakout - DC Power Cable Specifications
 Specifications per 1 pair:
 Maximum DC-Resistance Power Cable Ω/km (Ω/kft) 1.4 (0.42)
 Cross Section of Power Cable mm² (AWG) 13.3 (6)



HBF058-13U1SS3-15FS

HYBRIFLEX® RRH Hybrid Jumper, 5/8", 1 pair 6AWG, 3 Single Strand, Single-Mode Fiber with LC to Elongated LC Clip, 15 ft

Overall Cable Diameter mm (in) 18.6 (0.733)

DC Cable Jacket Material PVC/Nylon

EMI Shield Tinned Copper Braid

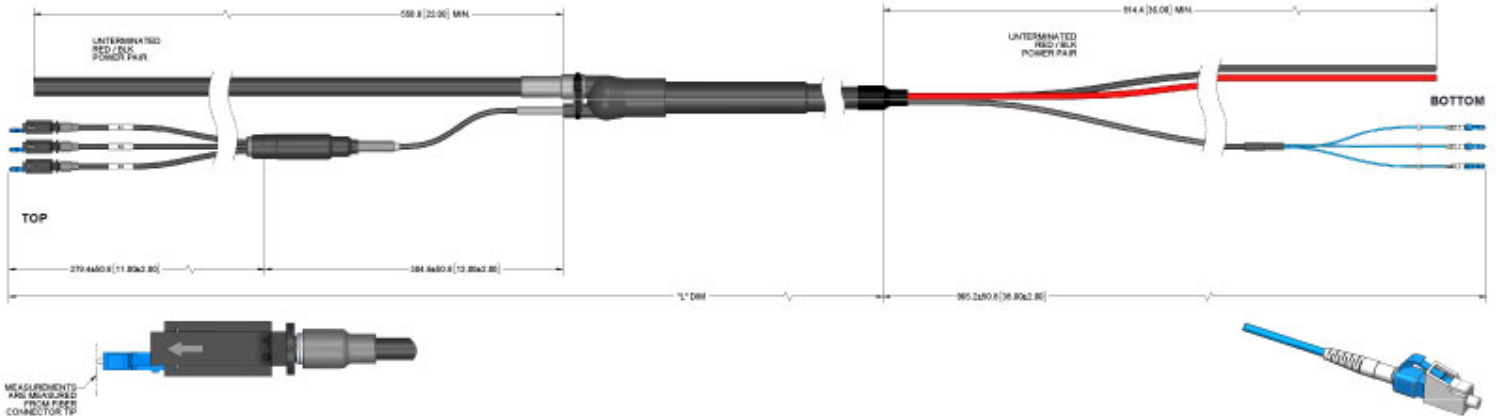

ADDITIONAL ASSEMBLIES - 1 STRAND SM FIBER

Length, ft	Model Number
15	HBF058-13U1SS-15FS
30	HBF058-13U1SS-30FS
40	HBF058-13U1SS-40FS

ADDITIONAL ASSEMBLIES - 2 STRAND SM FIBER

Length, ft	Model Number
15	HBF058-13U1SS2-15FS
30	HBF058-13U1SS2-30FS
40	HBF058-13U1SS2-40FS

ADDITIONAL ASSEMBLIES - 3 STRAND SM FIBER

Length, ft	Model Number
15	HBF058-13U1SS3-15FS
30	HBF058-13U1SS3-30FS
40	HBF058-13U1SS3-40FS
60	HBF058-13U1SS3-60FS

PRE-PACKED HYBRIFLEX KITS FOR EASY INTEGRATION INTO RAYCAP JUNCTION BOXES

RFS Technologies now offers Kitting options for most hybrid risers and jumpers that include both the cable assembly and the Raycap inserts. For reference, kits have a "K" as the third digit in the model number. HB158 does not require an additional gland/insert for proper installation and sealing into the Distribution Boxes.



HBF058-13U1SS3-15FS

HYBRIFLEX® RRH Hybrid Jumper, 5/8", 1 pair 6AWG, 3 Single Strand, Single-Mode Fiber with LC to Elongated LC Clip, 15 ft

Kit Model Prefix	Assembly Prefix	Assembly Qty	Raycap Insert Kit	Insert Kit Contents	Raycap Insert Kit Qty
HBK114	HB114	1	RFS Technologies-TRUNK-KIT	(2) 190 0620, Insert, M75, 1H, 40mm	1
HBK058	HBF058		RFS Technologies-JUMP-KIT	(1) 190 0621, Insert, M75, 3H, 22mm, Split w/ plugs	
HBK012	HBF012		RFS Technologies-JUMP-KIT-2	(1) 190 0903, Insert, M75, 2H, 15mm, Split w/ plugs	
FRK-N	FR-N		RFS Technologies-FIBER-KIT	(1) 190 0657, Insert, M75, 6H, 6.1mm, Split w/ plugs	