



RFS Technologies TPS* Tapper product family has been designed to support a variety of wireless applications in the frequency band from 694 to 3800MHz. The units couple off a defined fraction of a RF signal from typically 3 to 30 dB with minimal reflections or loss. The broad frequency range is ideally suited for 3G / 4G / 5G multi-band distributed antenna systems or in combination with RADIAFLEX® radiating cables. Notably, these products feature a low level of network interferences due to their PIM optimized desing.

FEATURES / BENEFITS

- Split ratio 100:1 / 20dB
- 716-female interfaces
- PIM optimized design (160dBc @2x43dBm)
- Low insertion loss
- High power handling
- Small size, Low weight



TPS20-43-694/3800 (similar product illustration)

Technical features

STRUCTURE

Product Type		Unequal Divider/Tapper
Techn. Application		Indoor
Number of Input Ports		1
Number of Output Ports		2

ELECTRICAL SPECIFICATIONS

Frequency Range	MHz	694 - 3800
Connector Type		716 female
Max. VSWR / Return Loss	VSWR/dB	1.30/17.7 (1.3)
Insertion Loss max.	dB	0.2
Coupling Value	dB	20.1
Coupling Flatness max.	dB	+2.0 / -2.0
Intermodulation (IM3)		160dBc (2x43dBm)
Impedance	Ohm	50
Total Input Power	W	200

TEMPERATURE SPECIFICATIONS

Temperature Range	°C (°F)	-25 to +65 (-13 to +149)
-------------------	---------	--------------------------

MECHANICAL SPECIFICATIONS

Height	mm (in)	49.7 (1.96)
Width	mm (in)	19.5 (0.77)
Length	mm (in)	84.3 (3.32)



TESTING AND ENVIRONMENTAL

Environmental Class		IP65
----------------------------	--	------

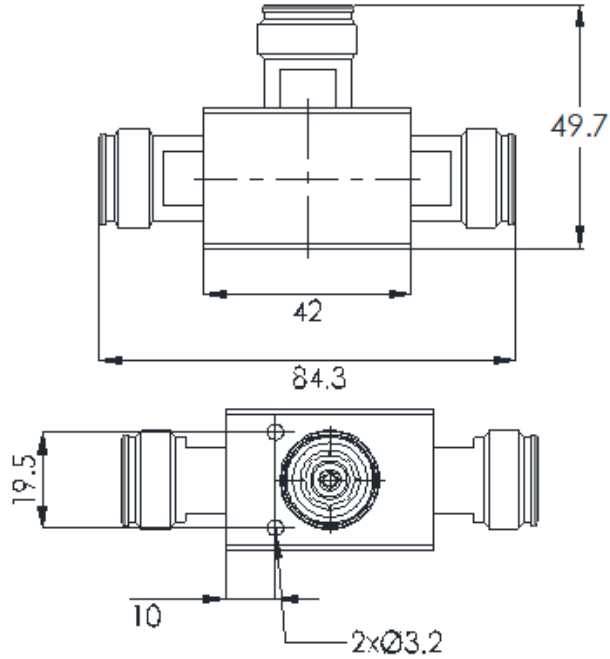

[External Document Links](#)

[Notes](#)