



RFS Technologies TPS* Tapper product family has been designed to support a variety of wireless applications in the frequency band from 694 to 3800MHz. The units couple off a defined fraction of a RF signal from typically 3 to 30 dB with minimal reflections or loss. The broad frequency range is ideally suited for 3G / 4G / 5G multi-band distributed antenna systems or in combination with RADIAFLEX® radiating cables. Notably, these products feature a low level of network interferences due to their PIM optimized desing.

FEATURES / BENEFITS

- Split ratio 3:1 / 5dB
- 4.3-10-female interfaces
- PIM optimized design (160dBc @2x43dBm)
- Low insertion loss
- High power handling
- Small size, Low weight



TPS5-43-694/3800 (similar product illustration)

Technical features

STRUCTURE

| | | |
|------------------------|--|------------------------|
| Product Type | | Unequal Divider/Tapper |
| Techn. Application | | Indoor |
| Number of Input Ports | | 1 |
| Number of Output Ports | | 2 |

ELECTRICAL SPECIFICATIONS

| | | |
|-------------------------|---------|------------------|
| Frequency Range | MHz | 694 - 3800 |
| Connector Type | | 4.3-10 female |
| Max. VSWR / Return Loss | VSWR/dB | 1.40/15.6 (1.4) |
| Insertion Loss max. | dB | 1.4 |
| Coupling Value | dB | 6.1 |
| Coupling Flatness max. | dB | +1.0 / -2.0 |
| Intermodulation (IM3) | | 160dBc (2x43dBm) |
| Impedance | Ohm | 50 |
| Total Input Power | W | 400 |

TEMPERATURE SPECIFICATIONS

| | | |
|-------------------|---------|--------------------------|
| Temperature Range | °C (°F) | -25 to +65 (-13 to +149) |
|-------------------|---------|--------------------------|

MECHANICAL SPECIFICATIONS

| | | |
|--------|---------|-------------|
| Height | mm (in) | 49.7 (1.96) |
| Width | mm (in) | 19.5 (0.77) |
| Length | mm (in) | 84.3 (3.32) |



TESTING AND ENVIRONMENTAL

Environmental Class

IP65

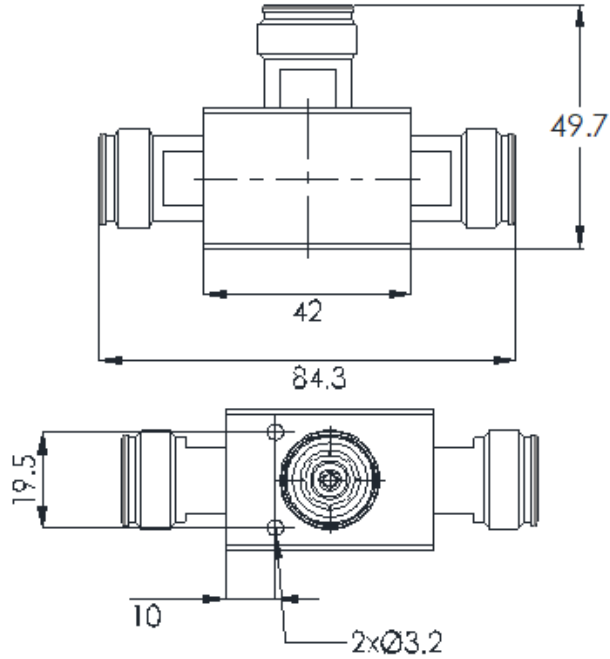

External Document Links

Notes